

Database Design

DBS can take care automatically of many things –
but the user has to specify

- Requirements of the application
- Characteristics of the data

Two important concepts during DBS design:

- Data Model: How to describe the data?
- Data Schema: Concrete description of the data
(using the chosen data model)

Data modeling

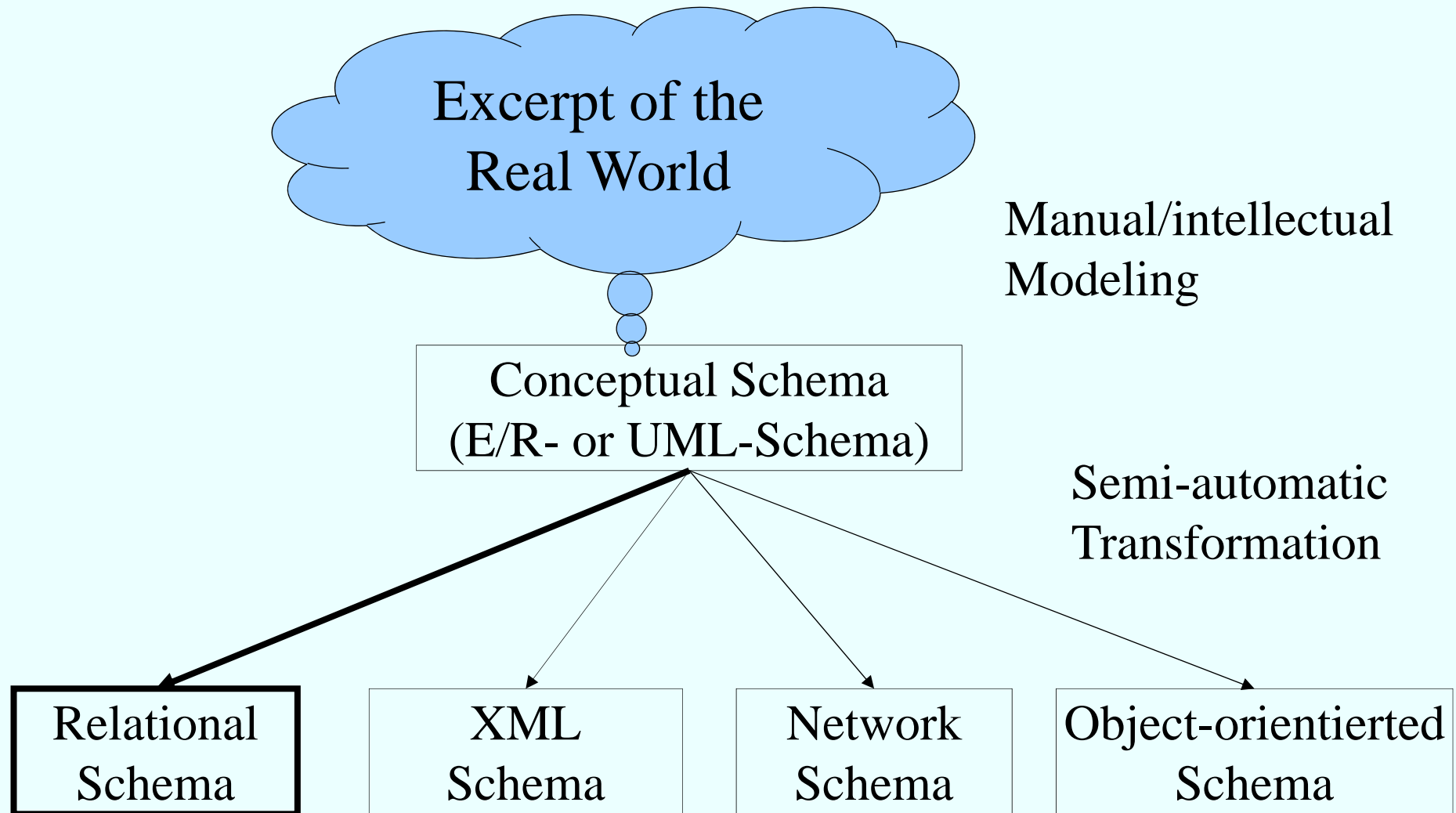

Logical Data Models

- Network Model
- Hierarchical Model
- Relational Data Model
- XML Model
- Object-orientierted Data Model
 - Object-relational Schema
- Deductive Data Model

Modeling a small example application: E/R

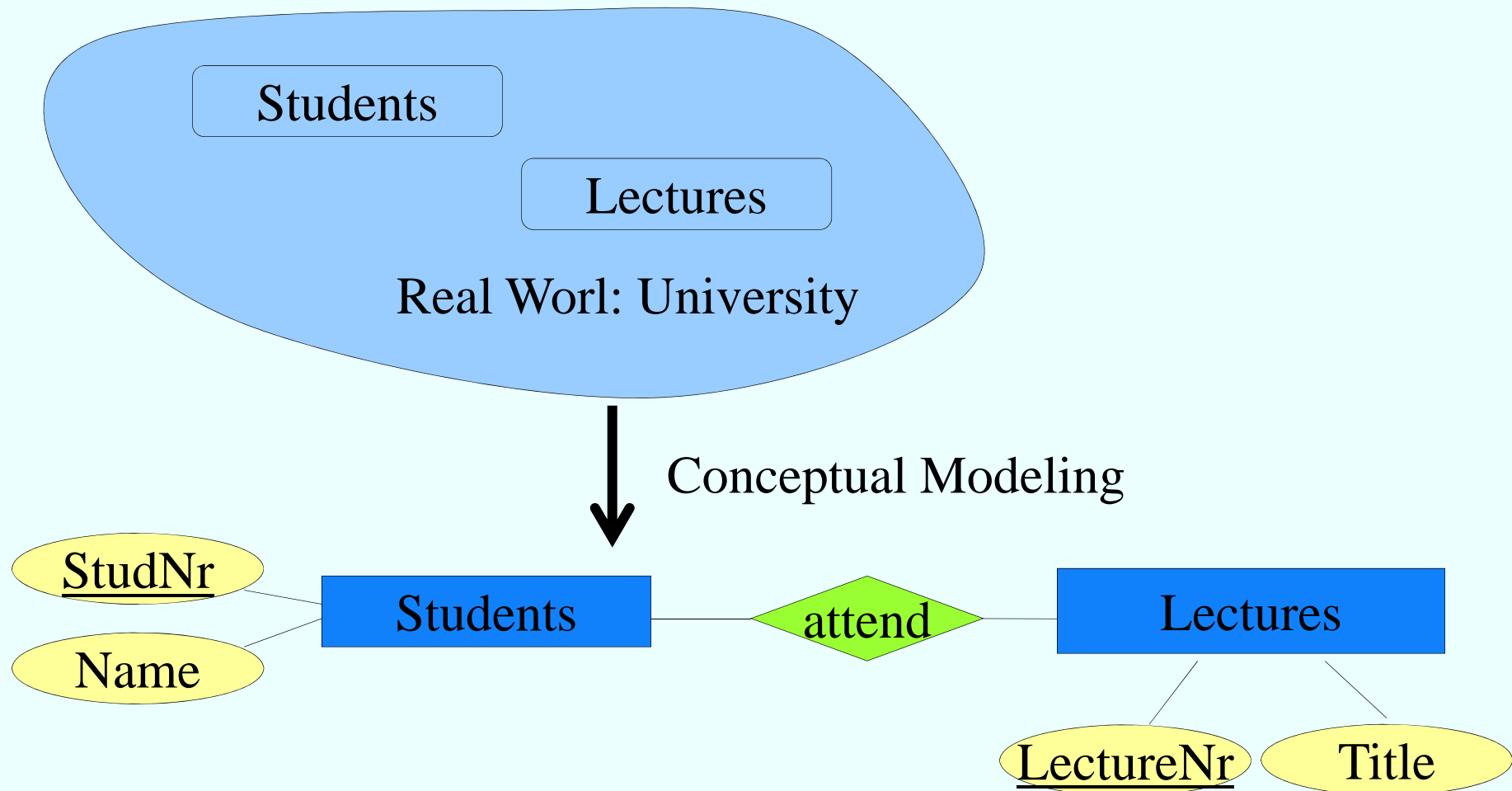

Modeling a small example application: UML

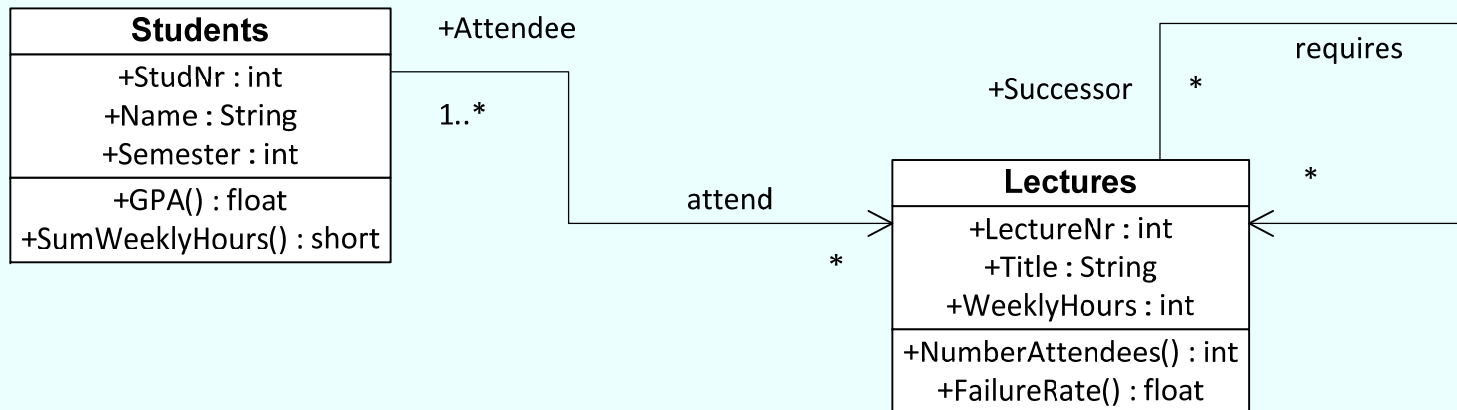
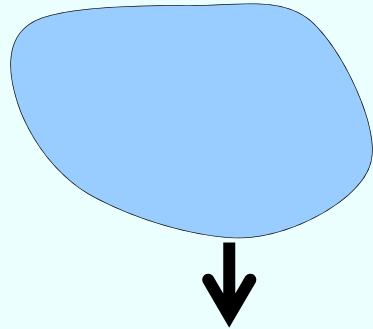

Relational Data Model

Students	
StudNr	Name
26120	Fichte
25403	Jonas
...	...

attend	
StudNr	Lecture Nr
25403	5022
26120	5001
...	...

Lectures	
Lecture Nr	Title
5001	Grundzüge
5022	Glaube und Wissen
...	...

```
Select Name
From Students, attend, Lectures
Where Students.StudNr = attend.StudNr and
        attend.LectureNr = Lectures.LectureNr and
        Lectures.Title = `Grundzüge`;
```

Database Design

Database Abstraction Layers

1. Conceptual Model
2. Logical Model
3. Physical Database Design

Phases of Database Design

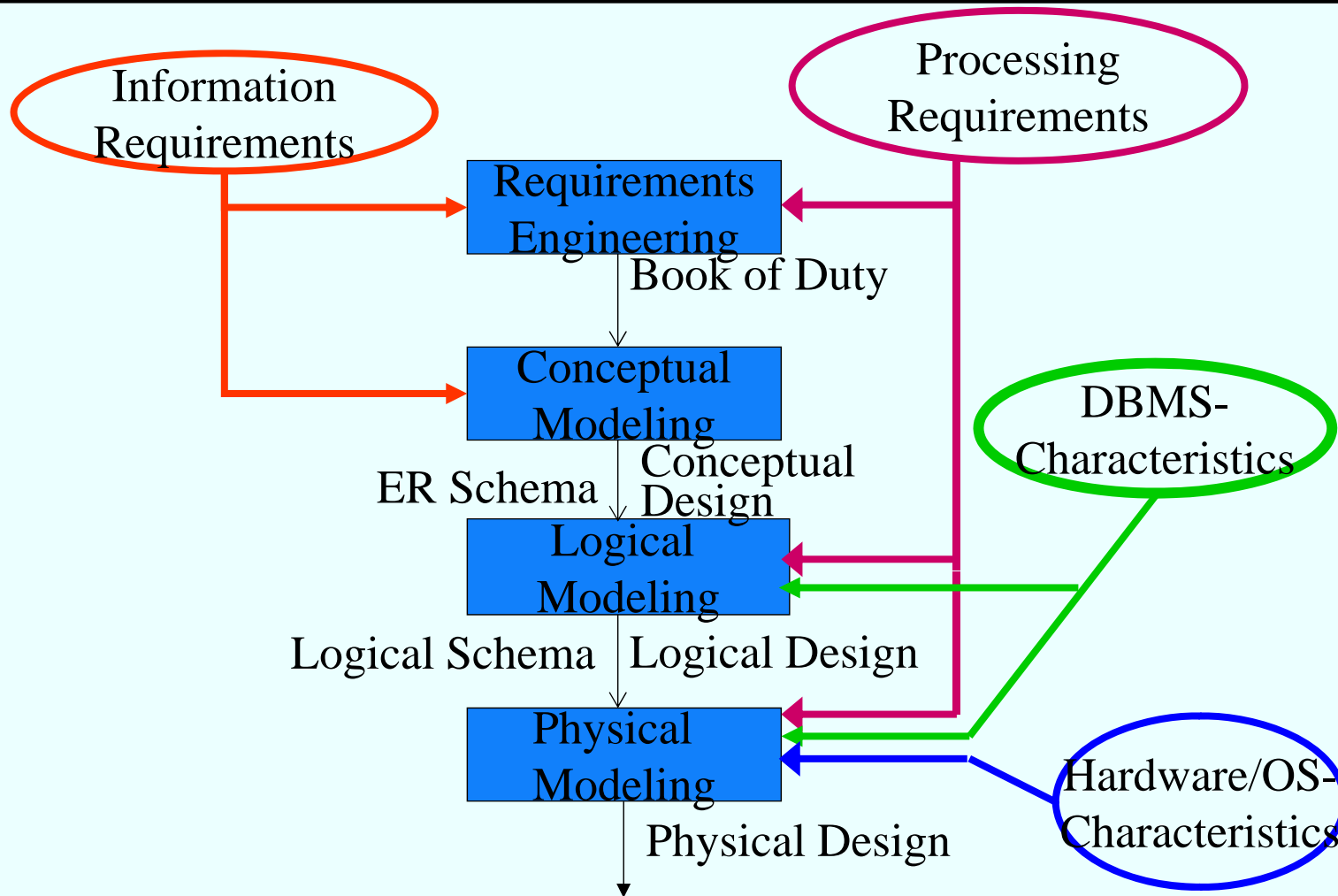

Software Development and Ability to Communicate



How the customer explained it



How the Project Leader understood it



How the Analyst designed it



How the Programmer wrote it



How the Business Consultant described it



How the project was documented

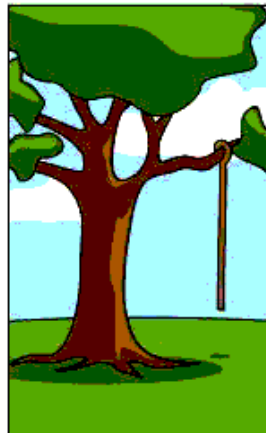

What operations installed



How the customer was billed



How it was supported

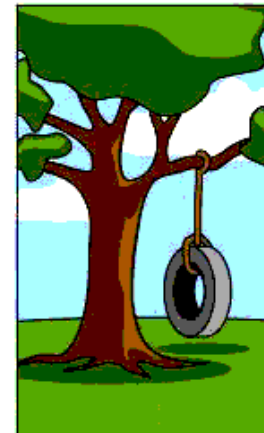

What the customer really needed

Schema Design

Approach in principle:

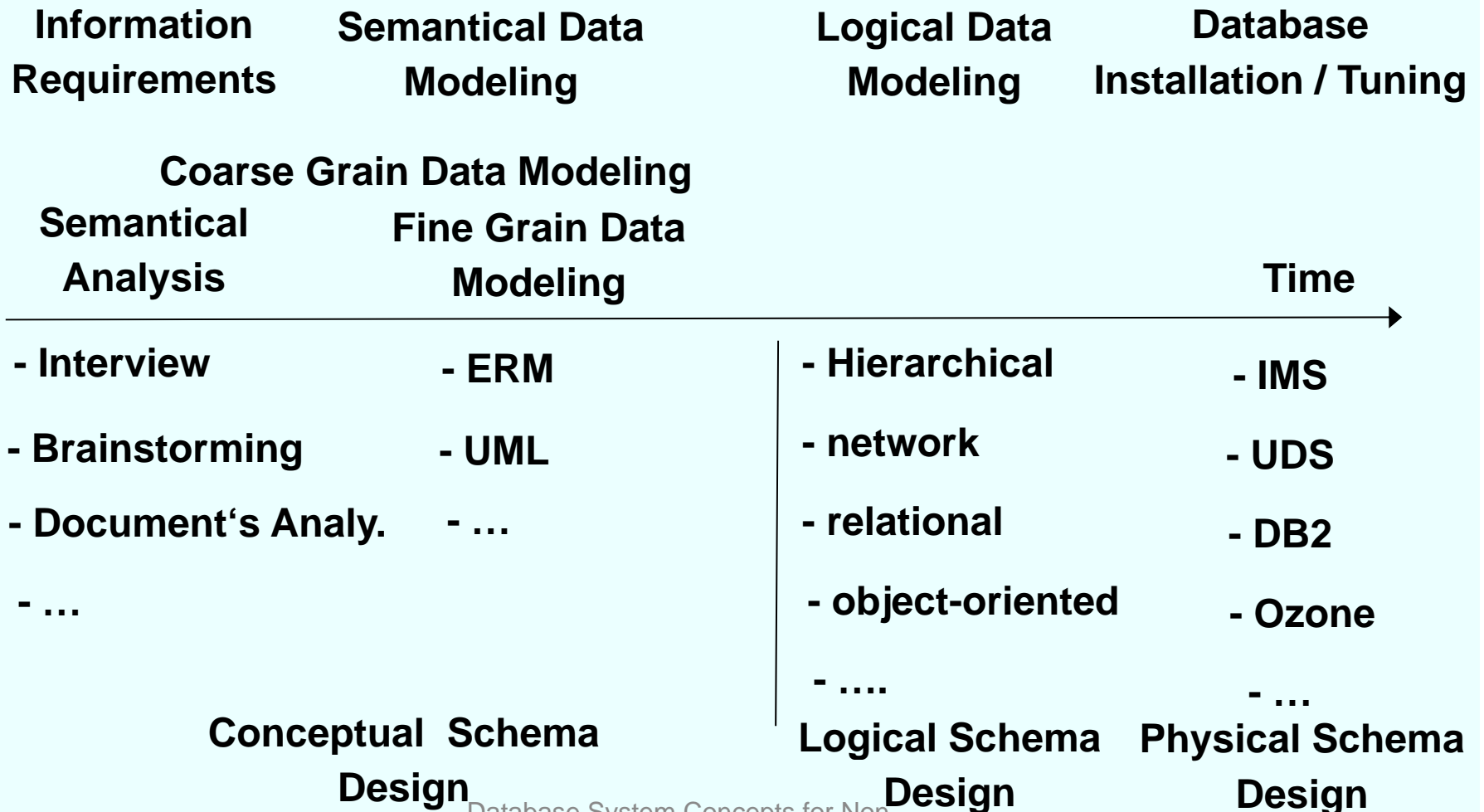

Object Description

University Employees

-Quantity: 1000

-Attributes

❖ EmpNumber

- Type: Integer
- Domain: 0...999.999.99
- Defined: 100%
- Identifying: yes
- Example: 007

❖ Salary

- Type: decimal
- Length: (7,2)
- Unit: Euro per month
- Defined: 10%
- Identifying: no

❖ Level

- Type: String
- Length: 2
- Defined: 100%
- Identifying: no
- Example: W2

Relation Description:

test

Involved Objects:

- Professor as Tester
- Student as Testee
- Lecture as Test Subject

Attributes of the Relation:

- Date
- Time
- Grade

Quantity: 100 000 per year

Process Description :

Issue a Certificate

- Frequency: semiannually
- Required Data
 - * Tests
 - * Examination Rules
 - * Student's Records
 - * ...
- Priority: high
- Data Volume to be processed
 - * 500 Students
 - * 3000 Tests
 - * 10 Versions of Examination Rules

Phases of Database Design

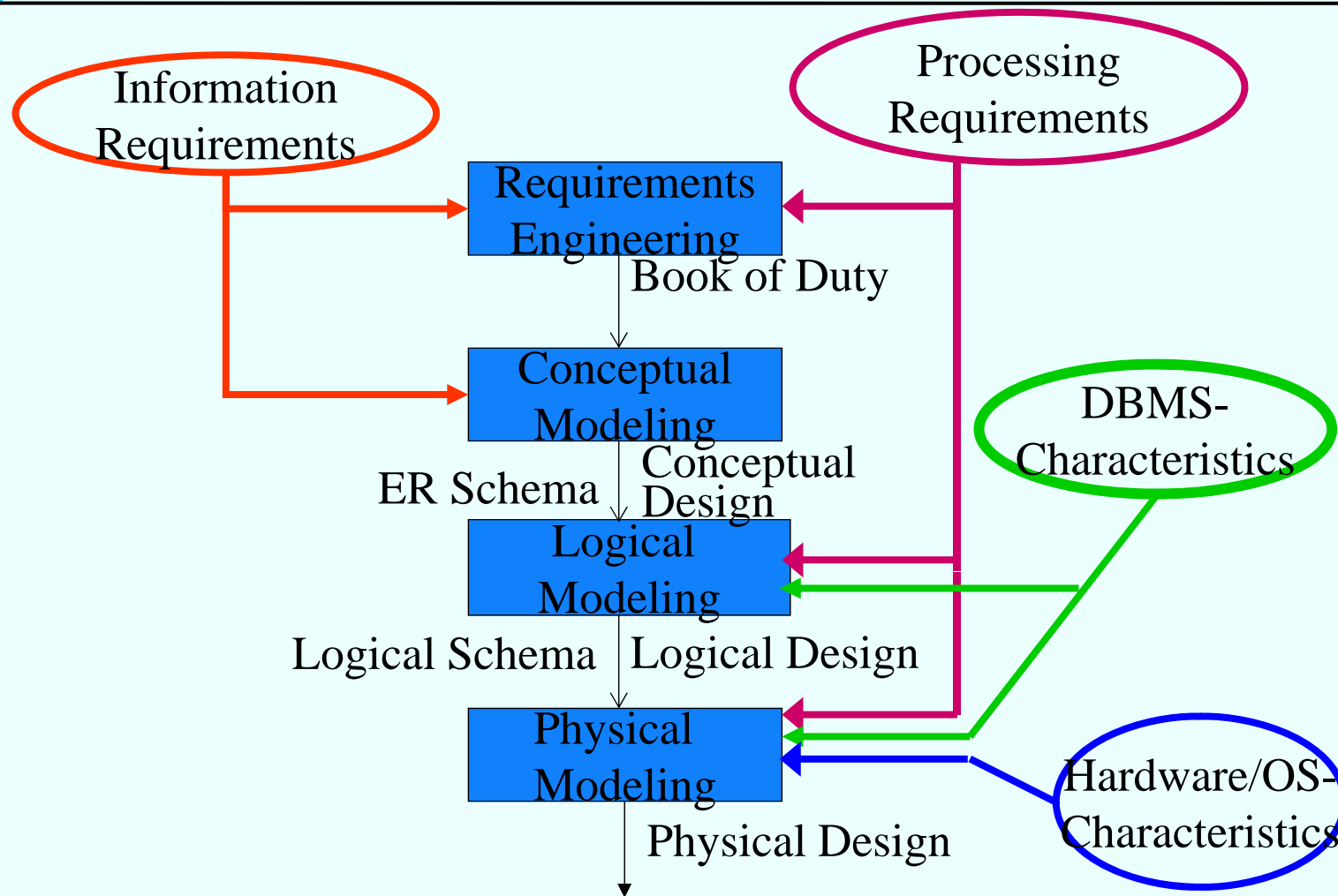

Conceptual Design

The ideal design (the ideal specification) is

- unique
- complete
- comprehensible (for all participants)
- nonredundant
- . . . and not reachable in reality

Creating a Specification

The actual analysis is an iterative process:

- Customer tells developer his/her needs
- Developer notes everything down (s/he understood) in his/her „language“ . . .
- . . . and translates it into the " language" of the customer
- This is shown to the customer who does not agree with everything
- Change requests are agreed on
- Back to step 2

Entity/Relationship-Modeling

Entity

Relationship

Attribute (property)

Key (identification)

Role

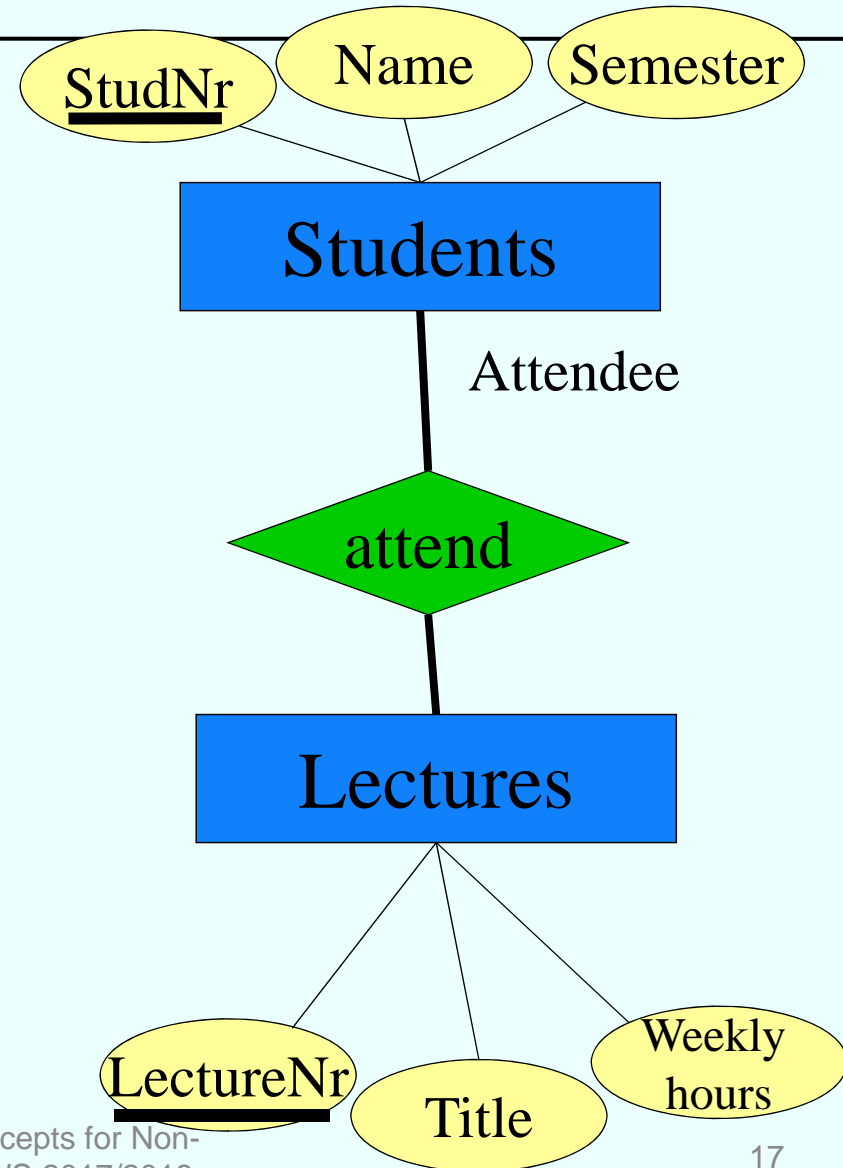

University Schema

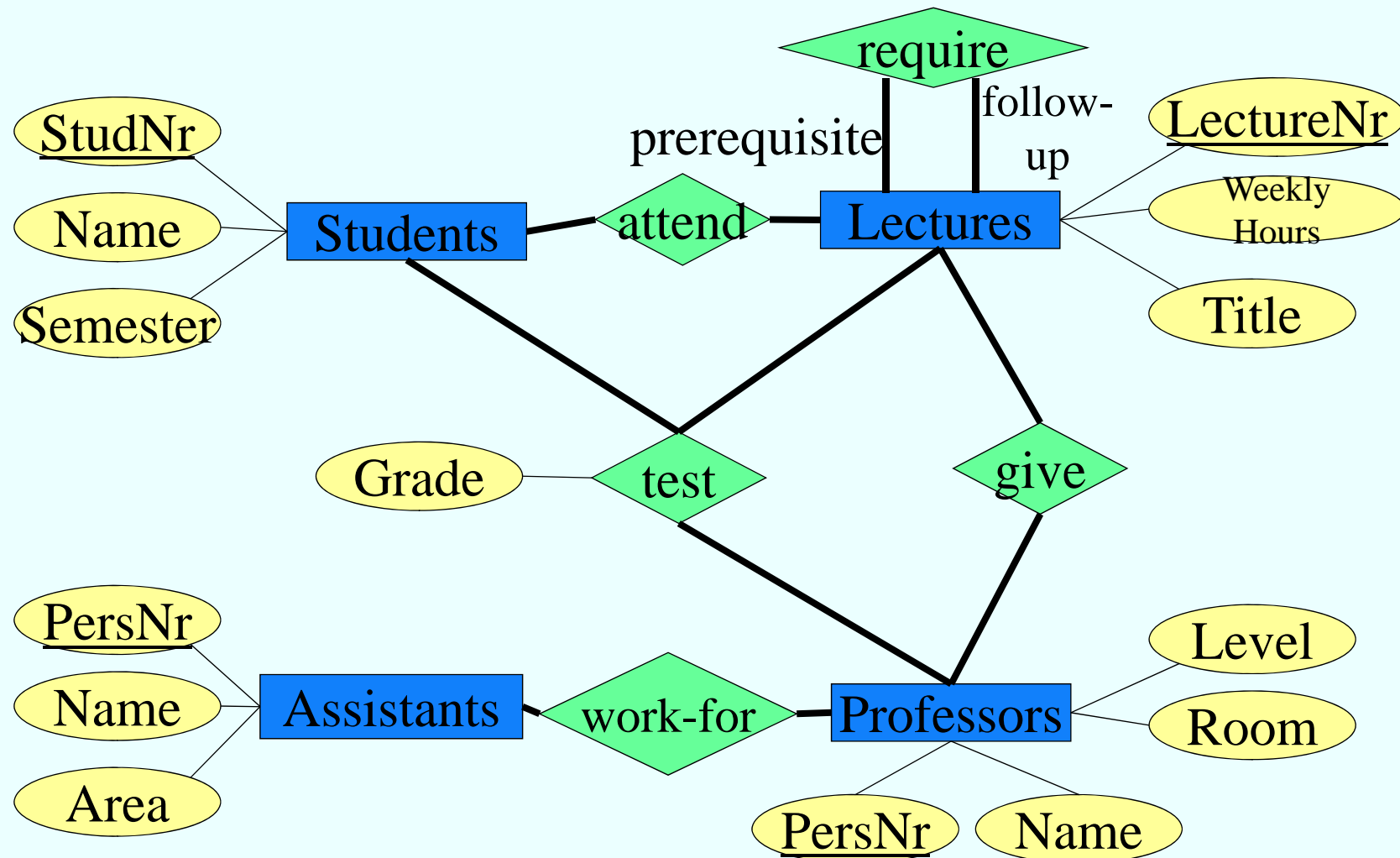

Functionalities

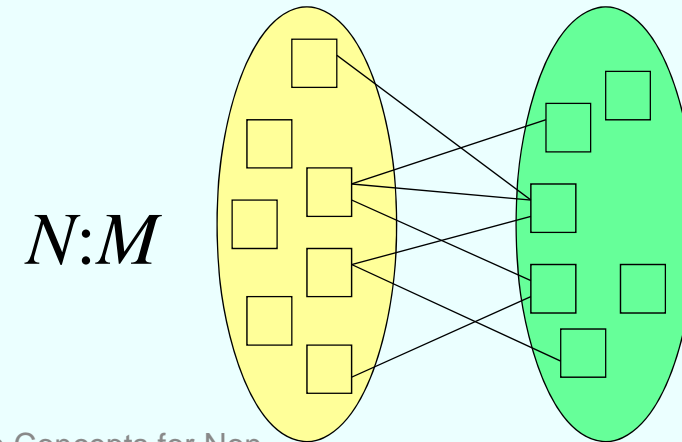
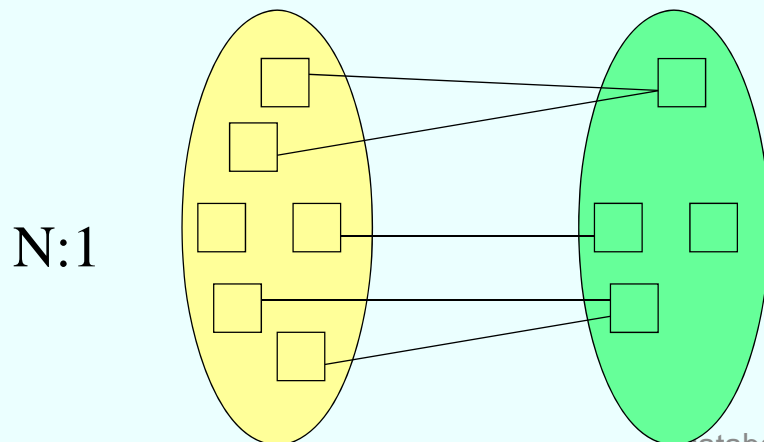
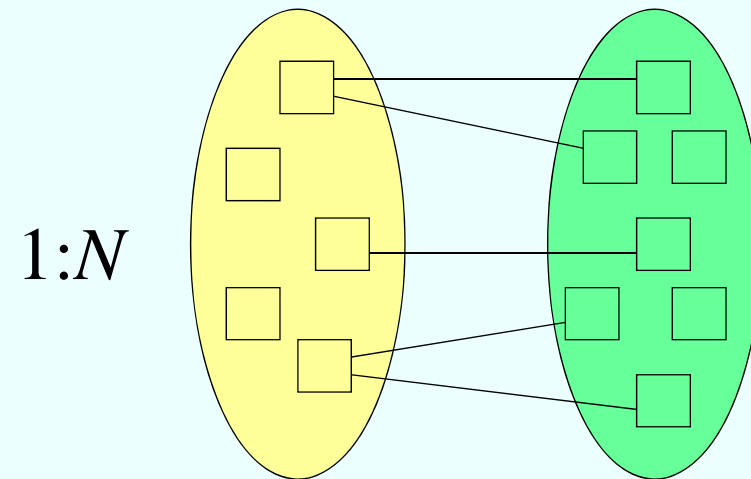
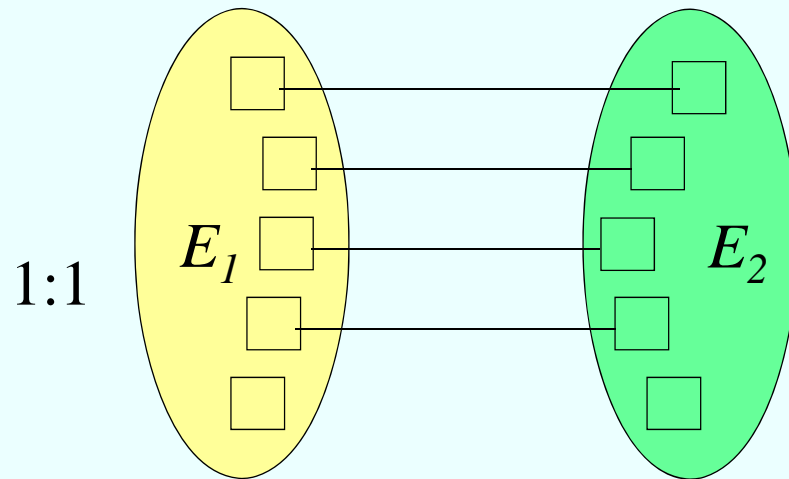
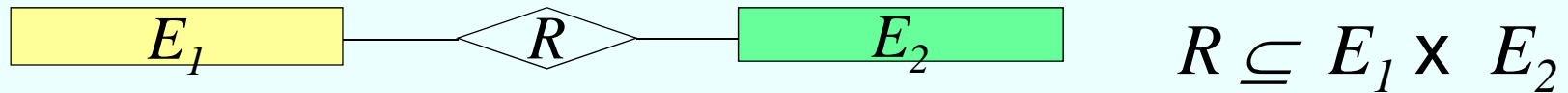

Relationship 1:1

Relationship 1:1

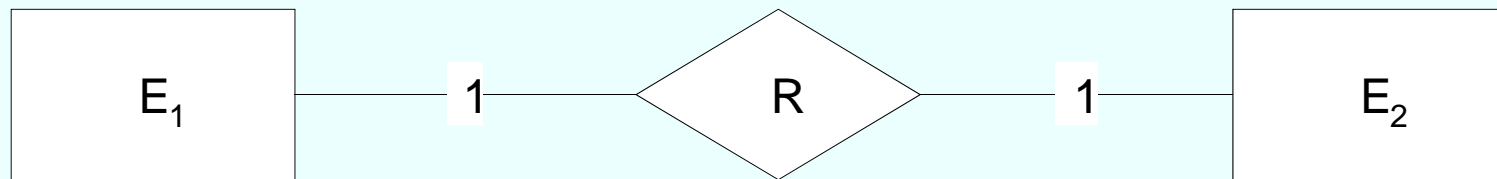

e_1 out of E_1 takes part in 1 relation of type R
 e_2 out of E_2 takes part in 1 relation of type R

Example:

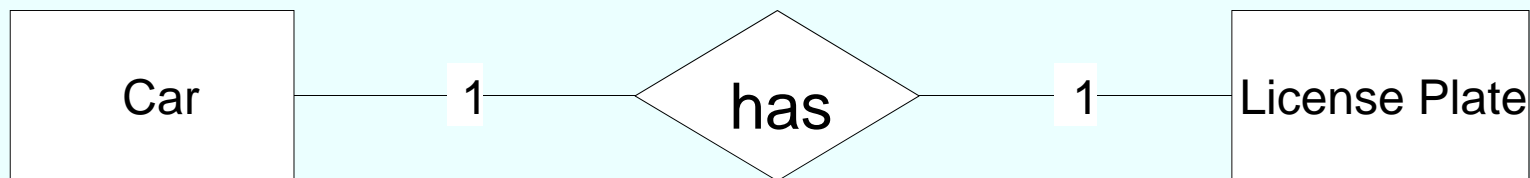

one car has one license plate
one license plate belongs to one car

Relationship 1:N

Relationship 1:N

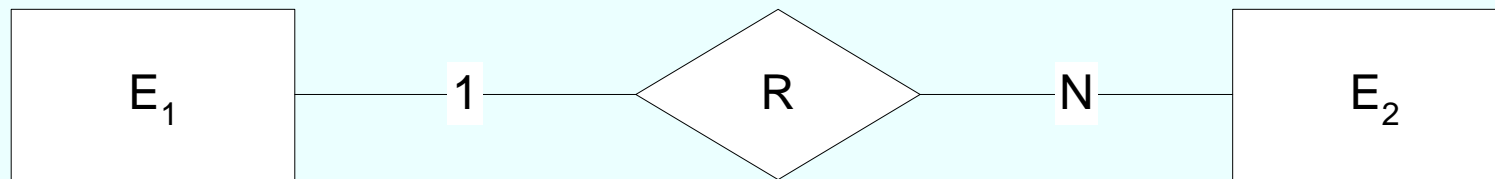

e_1 out of E_1 takes part in N relations of type R
 e_2 out of E_2 takes part in 1 relation of type R

Example:



one mentor advises several students
one student is advised by one mentor

Relationship N:M

Relationship N:M

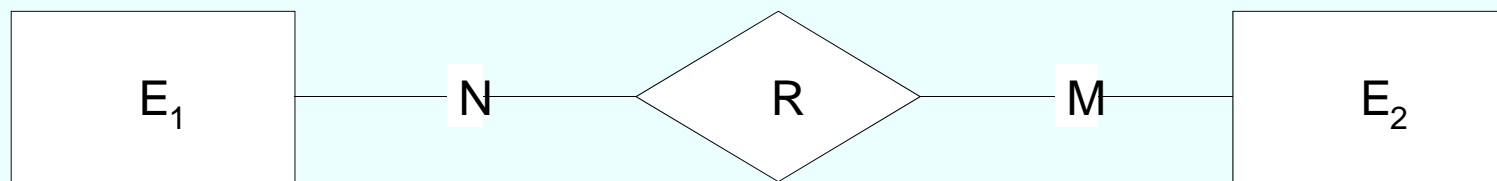

e_1 out of E_1 takes part in M relations of type R
 e_2 out of E_2 takes part in N relation of type R

Example:

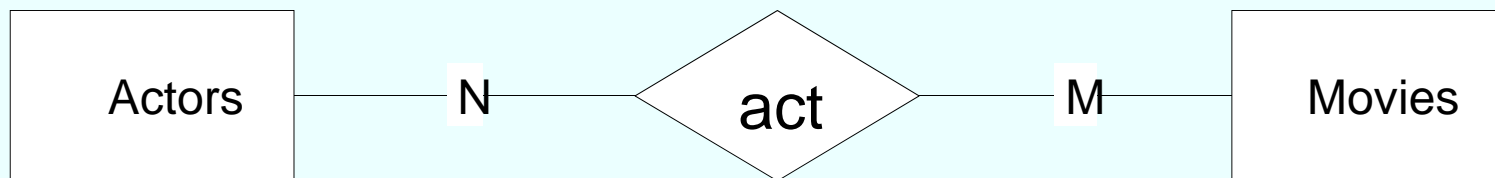

one actor acts in several movies
one movie has several actors

Unary Relationship 1:N

Relationship 1:N

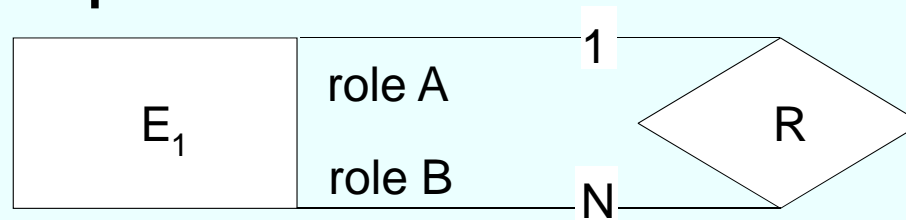

e_1 out of E_1 takes part in role A in N relations of type R
 e_1 out of E_1 takes part in role B in 1 relation of type R

Example:

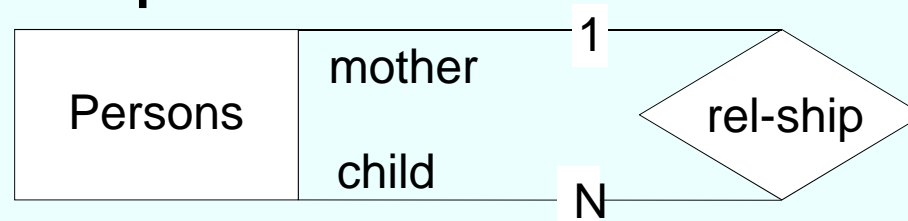

one person is mother of several persons (children)
one person is child of one person (mother)

Functionalities in n -ary Relationships

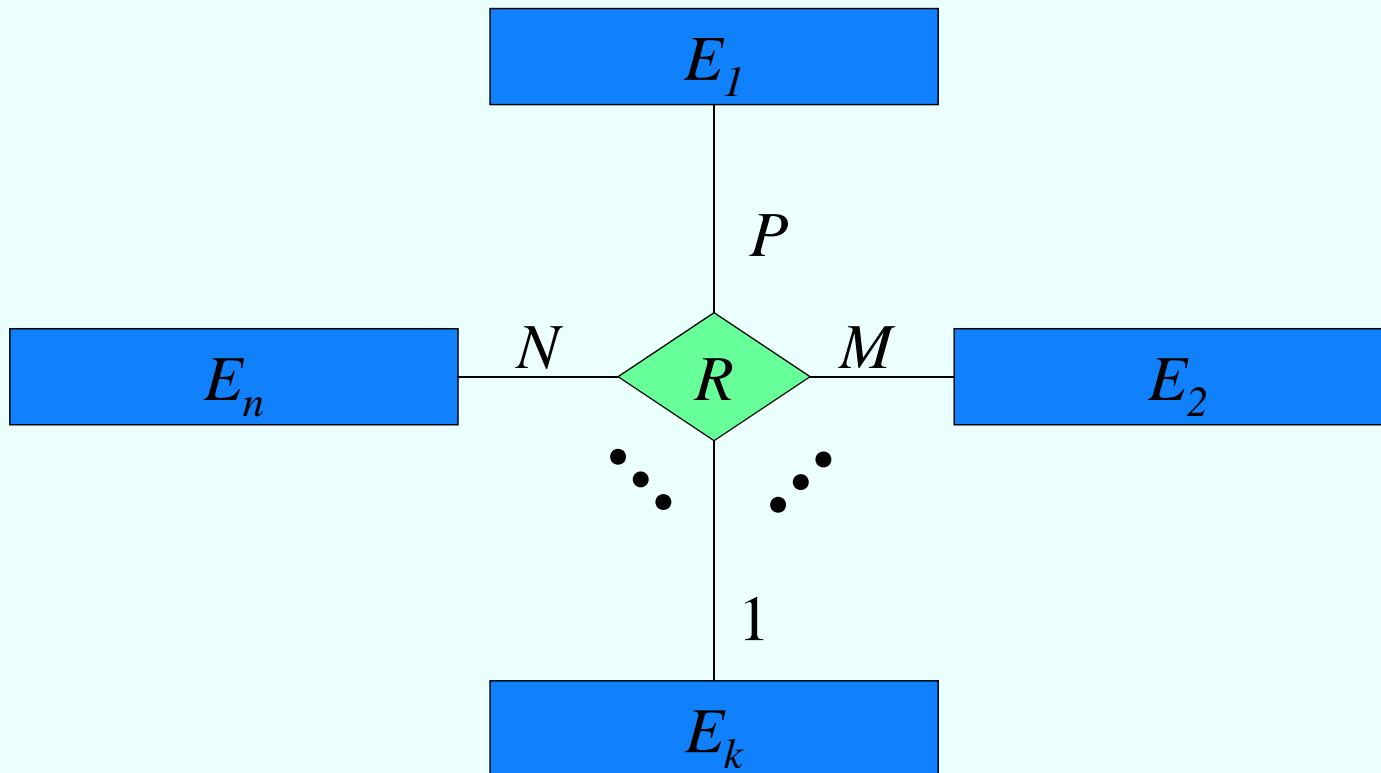

$$R : E_1 \times \dots \times E_{k-1} \times E_{k+1} \times \dots \times E_n \rightarrow E_k$$

Example Seminar

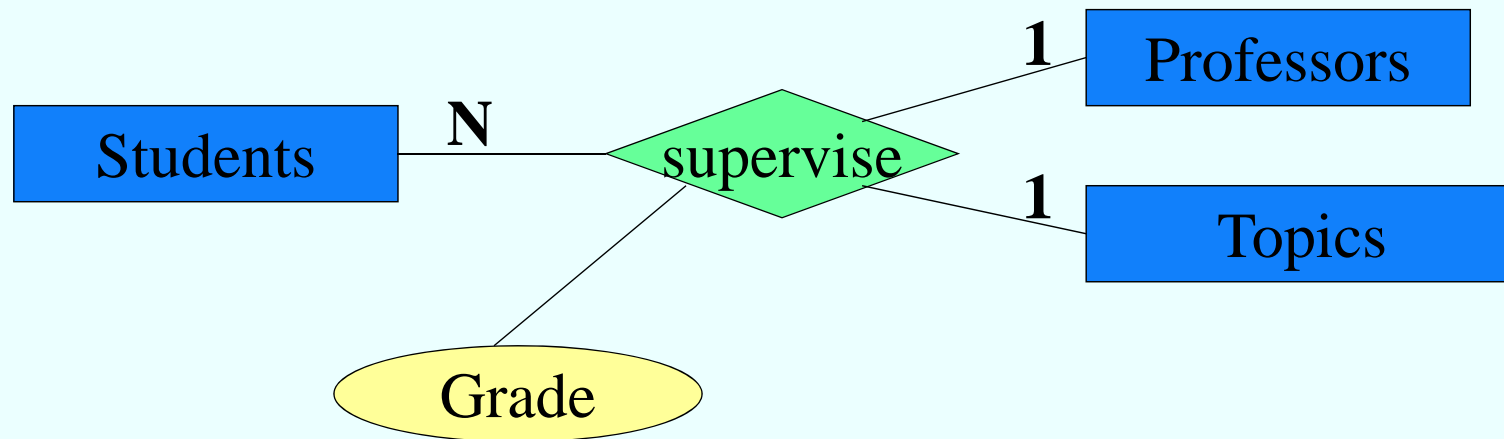

supervise : Professors \times Students \rightarrow Topics

supervise : Topics \times Students \rightarrow Professors

Thereby induced Consistency Constraints

1. Students may work on only one topic with the same professor (to cover a broad spectrum)
2. Students may work on the same topic only once – thus they may not work on the same topic again with another professor
3. Professors can reuse the same topic – i.e. give the same topic to different students
4. One topic can be given by different professors – but to different students

Occurrence of the Relationship *supervise*

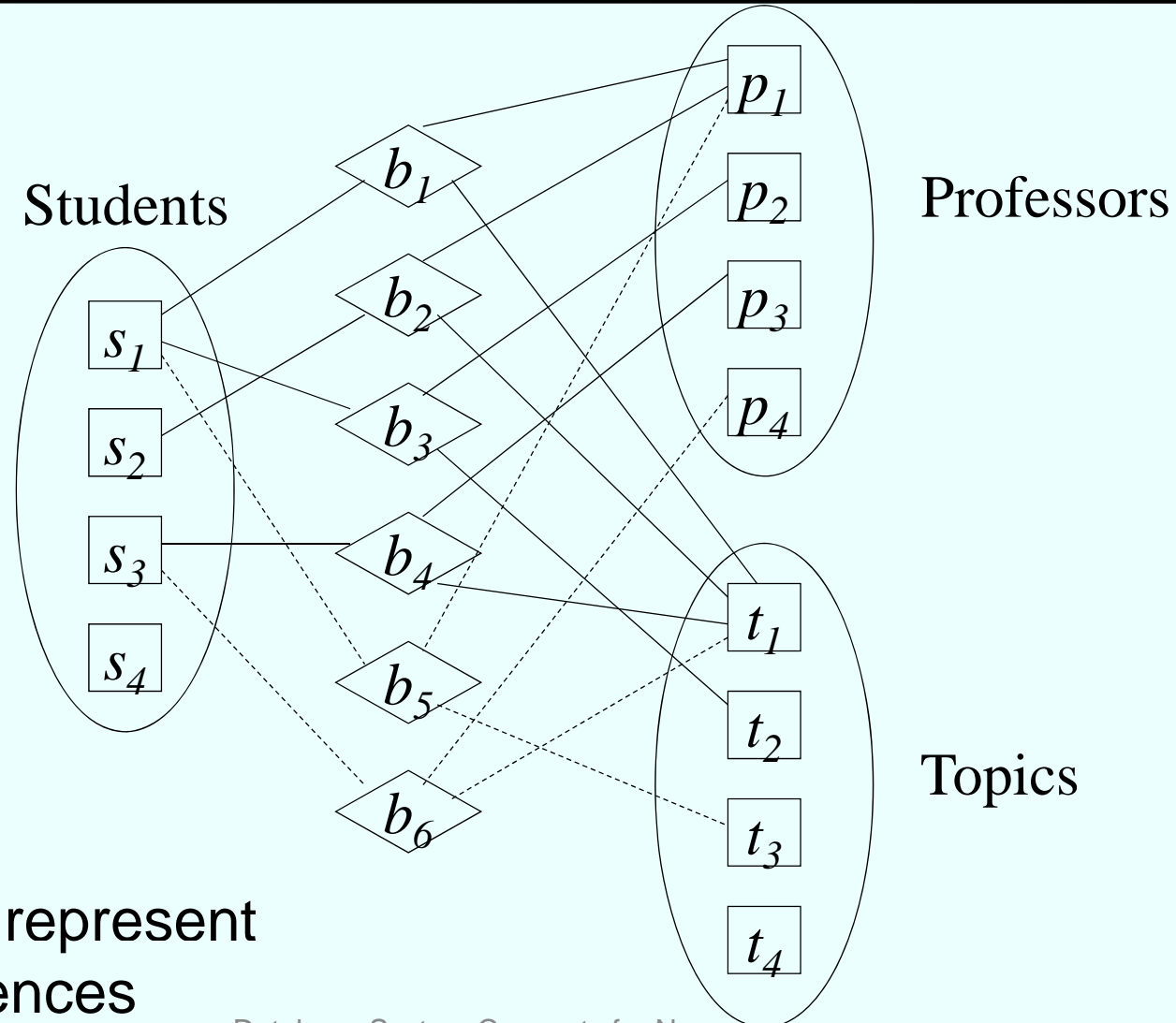

Dashed lines represent
illegal occurrences

One more Example

3-ary relationship:

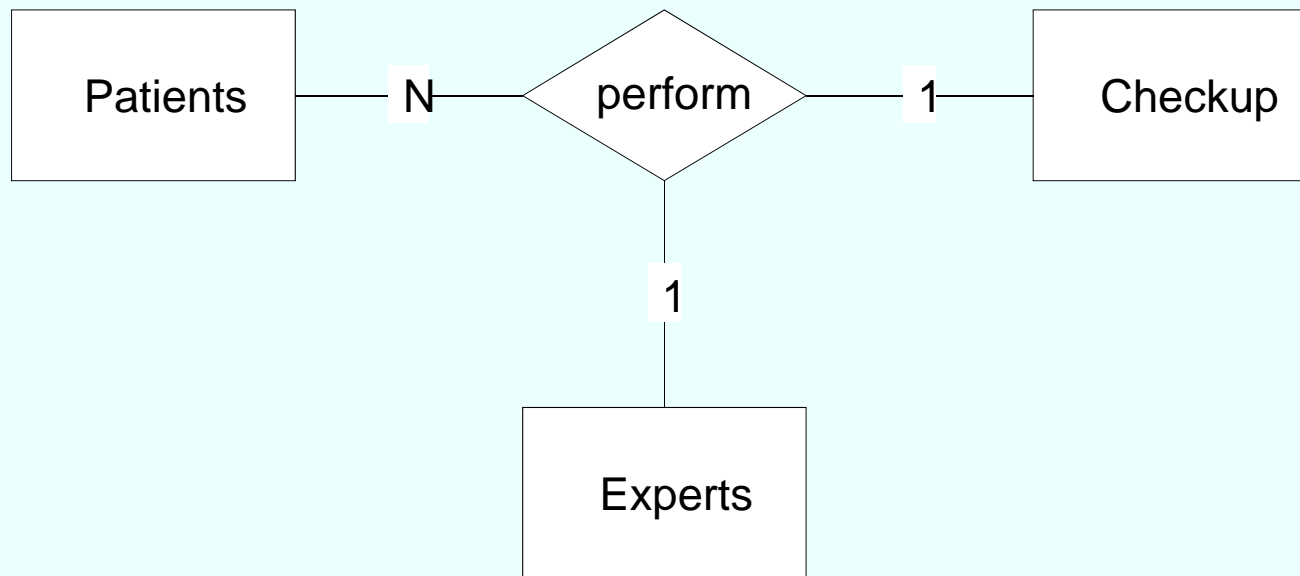

One checkup is performed by one expert with several patients

One Patient gets only one checkup from one expert

One checkup is performed at one patient only by one expert

University Schema

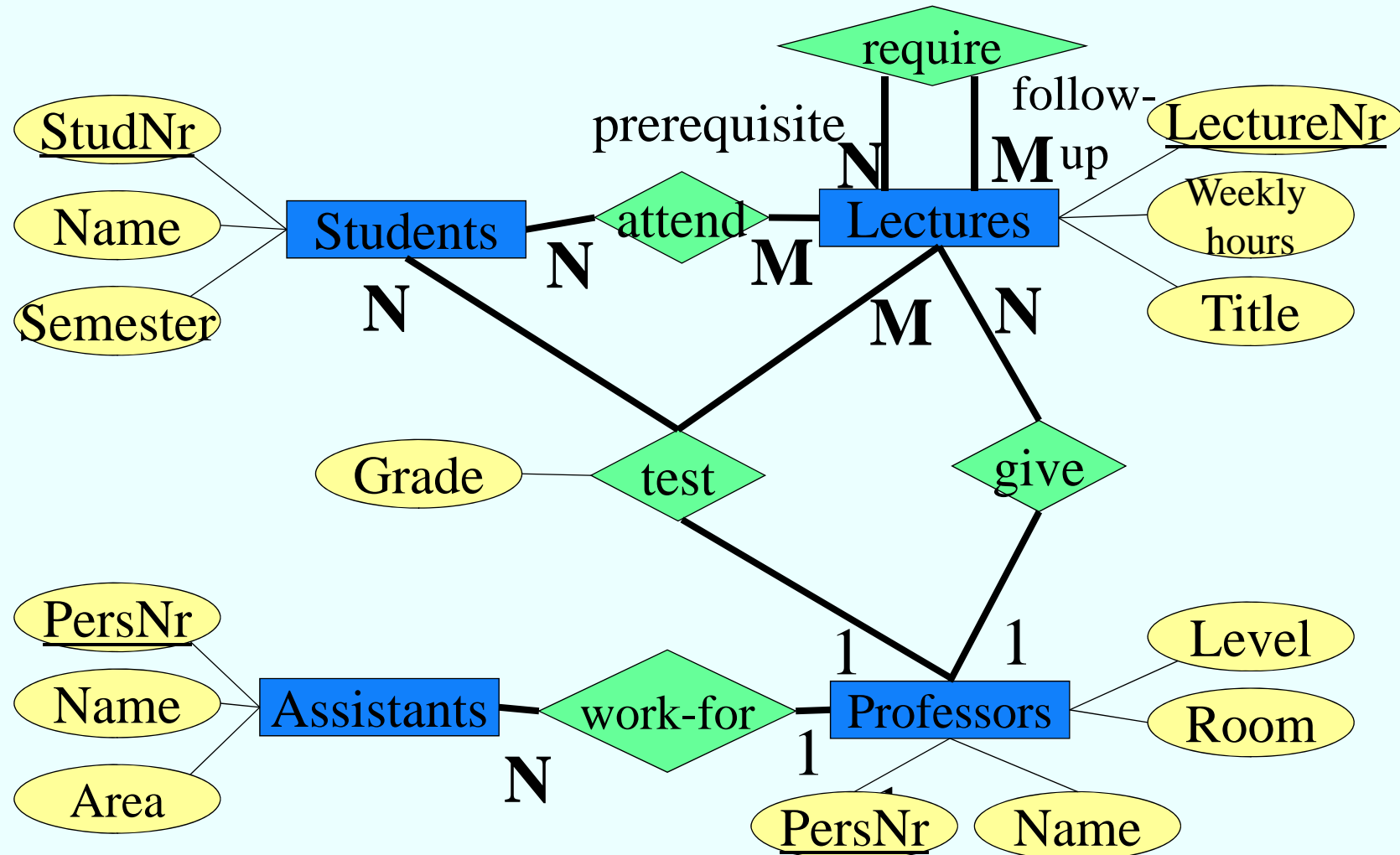

(min, max)-Notation

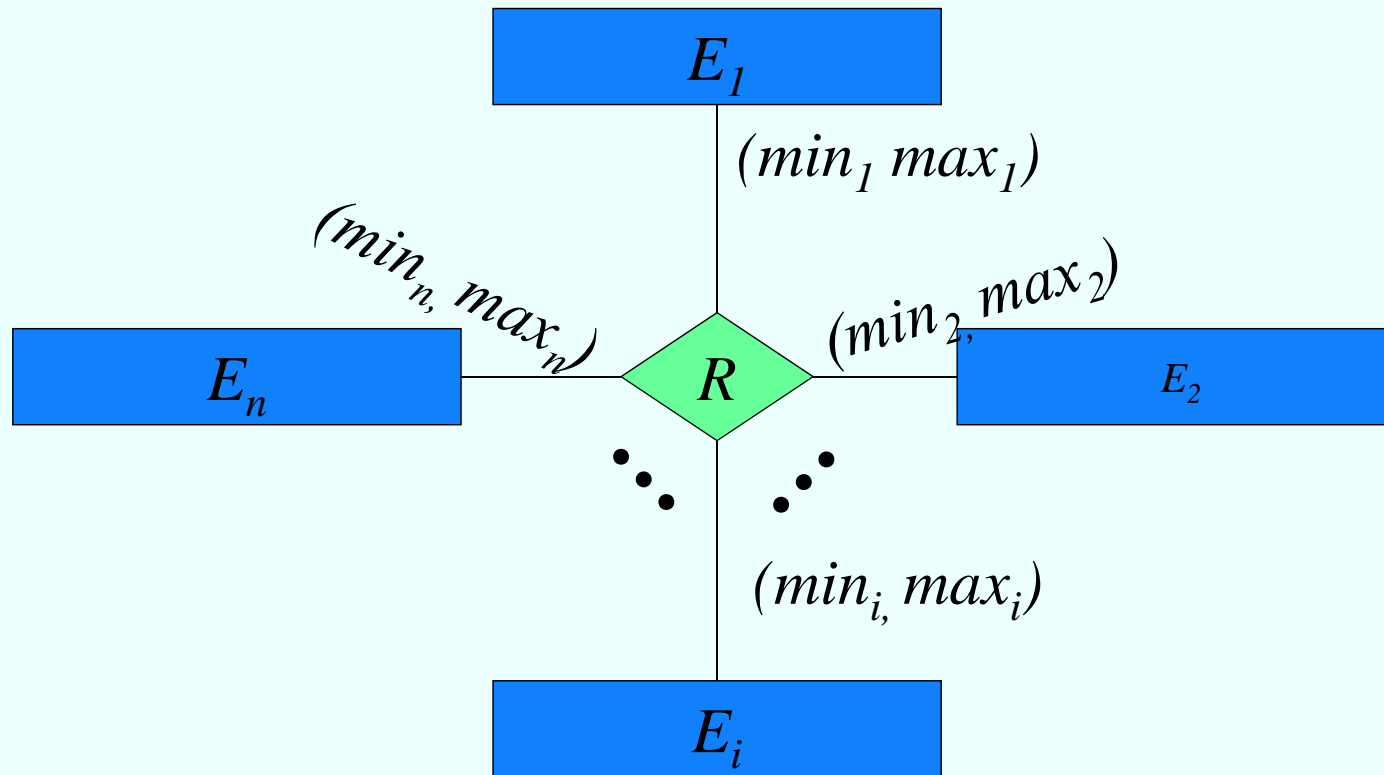

$$R \subseteq E_1 \times \dots \times E_i \times \dots \times E_n$$

For every $e_i \in E_i$ there are

- at least \min_i tuples $(\dots, e_i, \dots) \in R$ and
- at most \max_i tuples $(\dots, e_i, \dots) \in R$

Example (min, max)

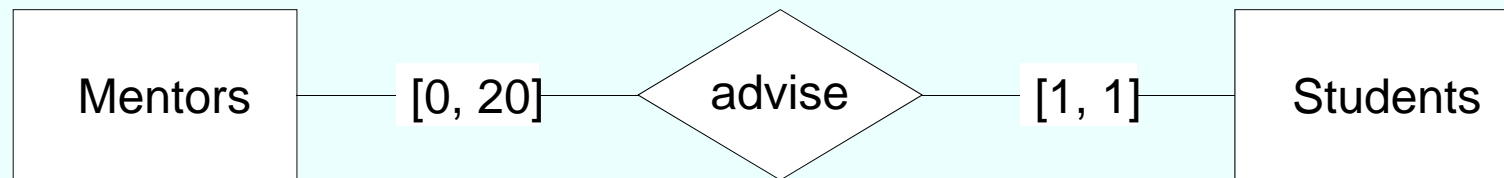

one mentor advises up to 20 students
one student is advised by exactly one mentor

Excercise for next class

Inform yourself about unary – binary – ternary relationships

Discussion / new examples next class!

Weak Entities

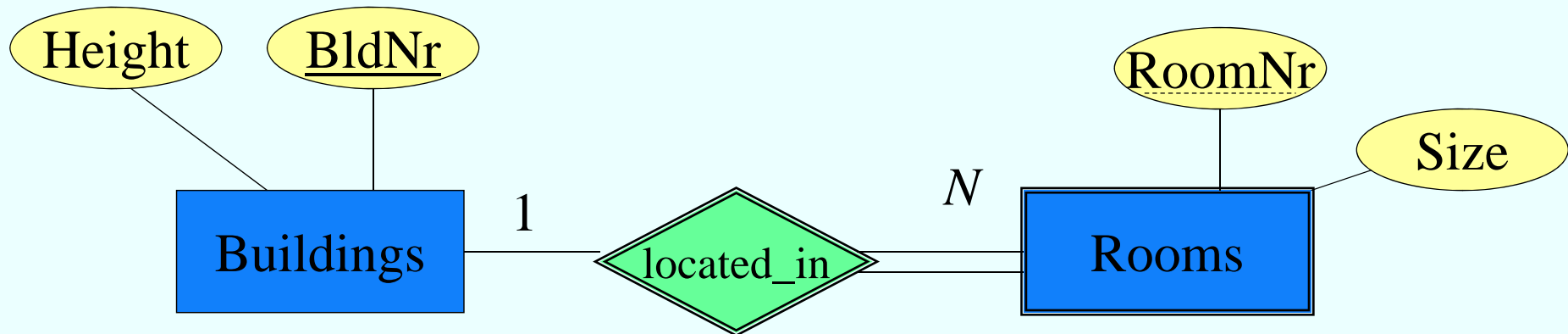

- Relationship between "strong" and "weak " type is 1: N (or 1:1 in rare cases) - why not $N:M$?
- The existence of a room depends on the existence of the associated building
- RoomNr is unique only within the building
- Key of Rooms is: RoomNr **and** BldNr

Tests as weak entity type

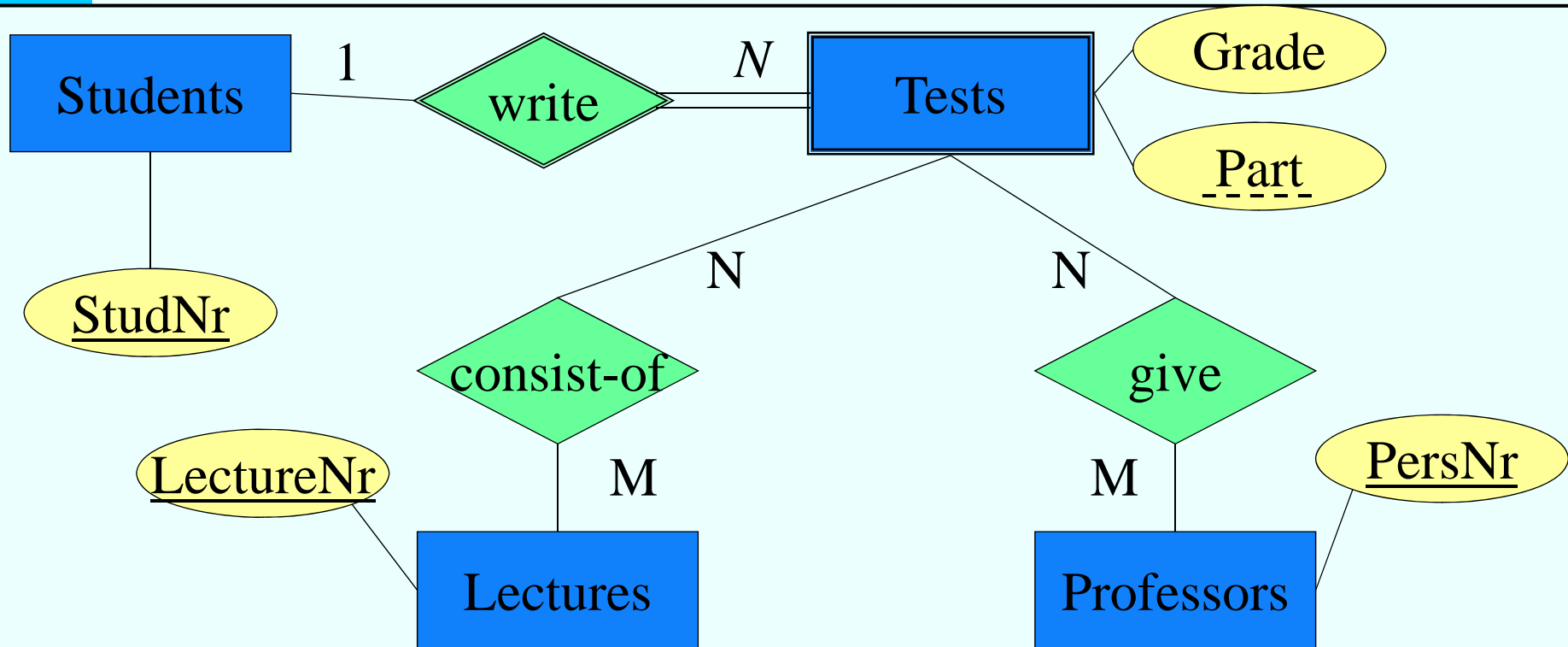

- Several professors design one test
- Several lectures are inquired in one test

Generalization

Generalization / Specialization:

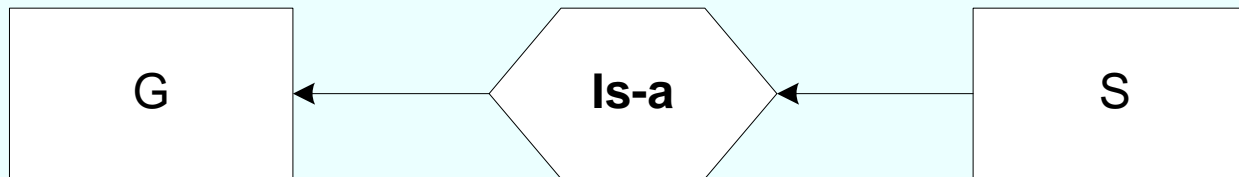

S is a specialization of G

Example:

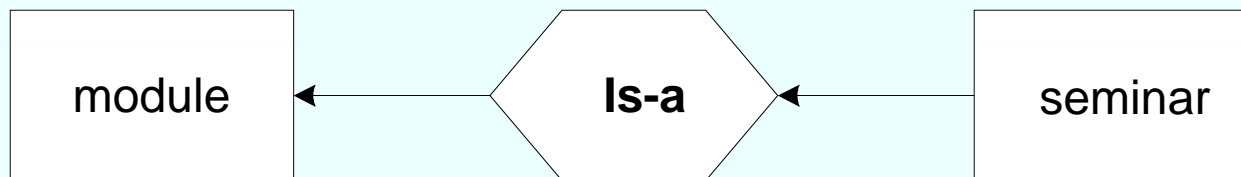

Generalization University

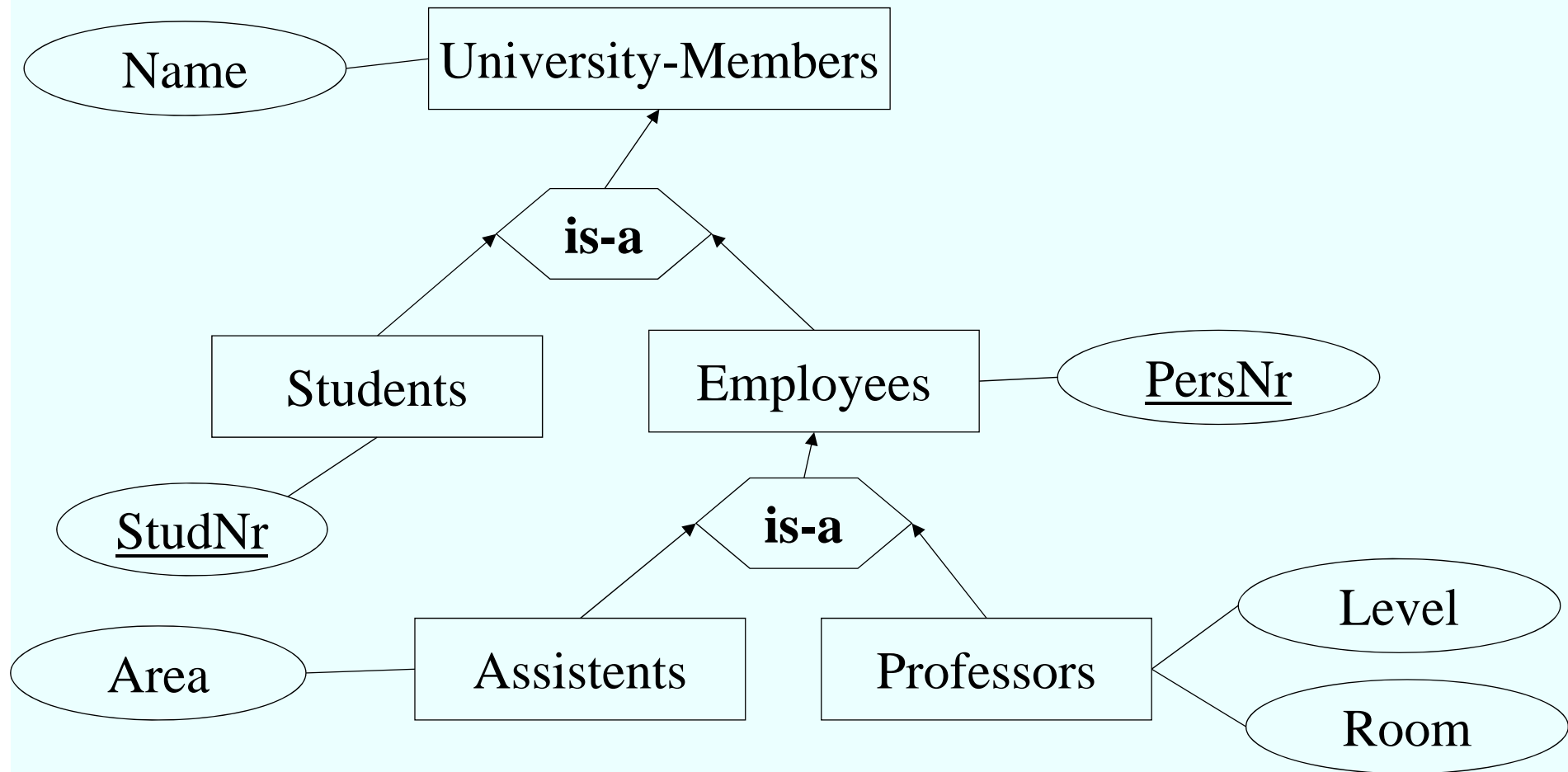

Conclusion

**University schema with
generalization and (min, max)-
notation**

→ Nextpage

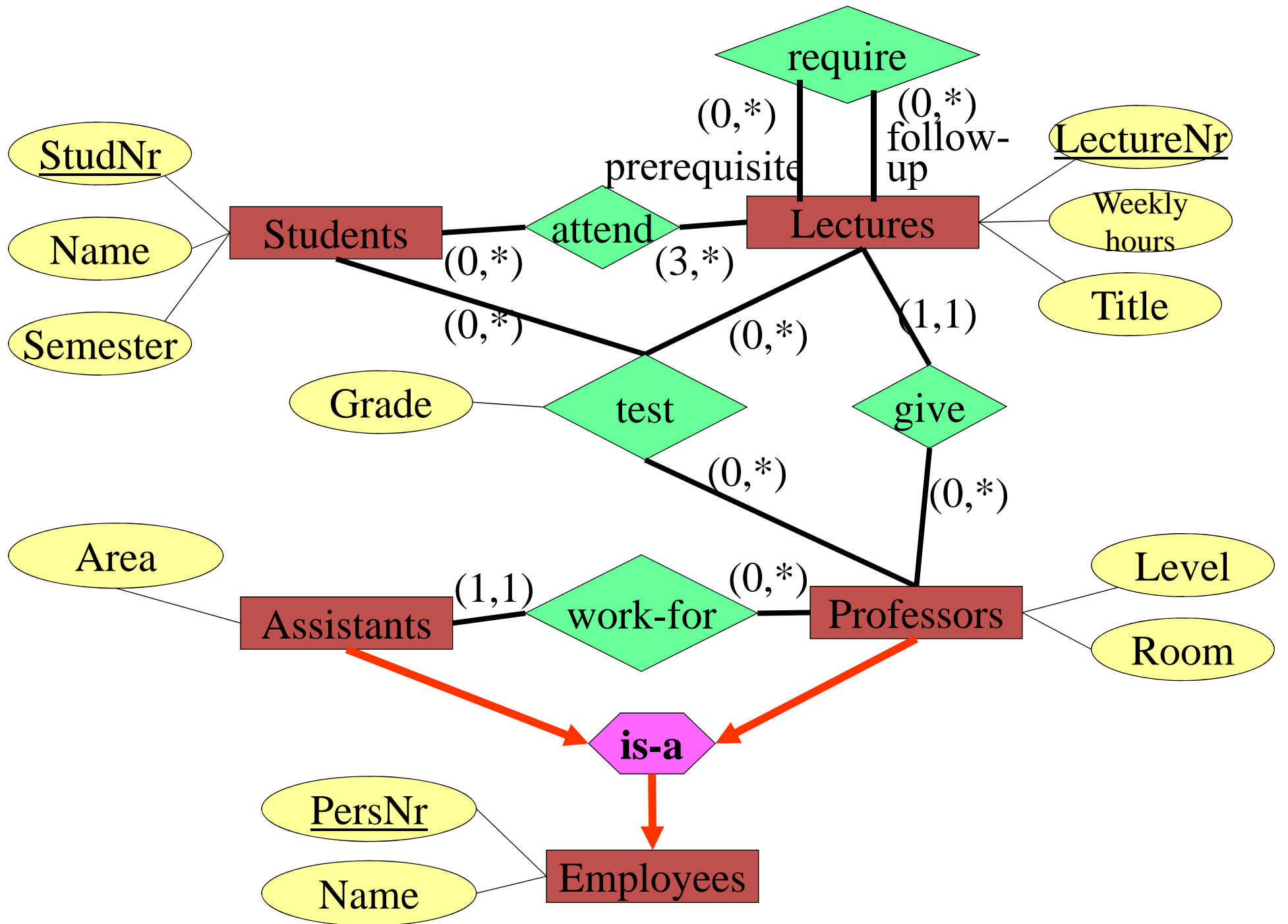

Aggregation

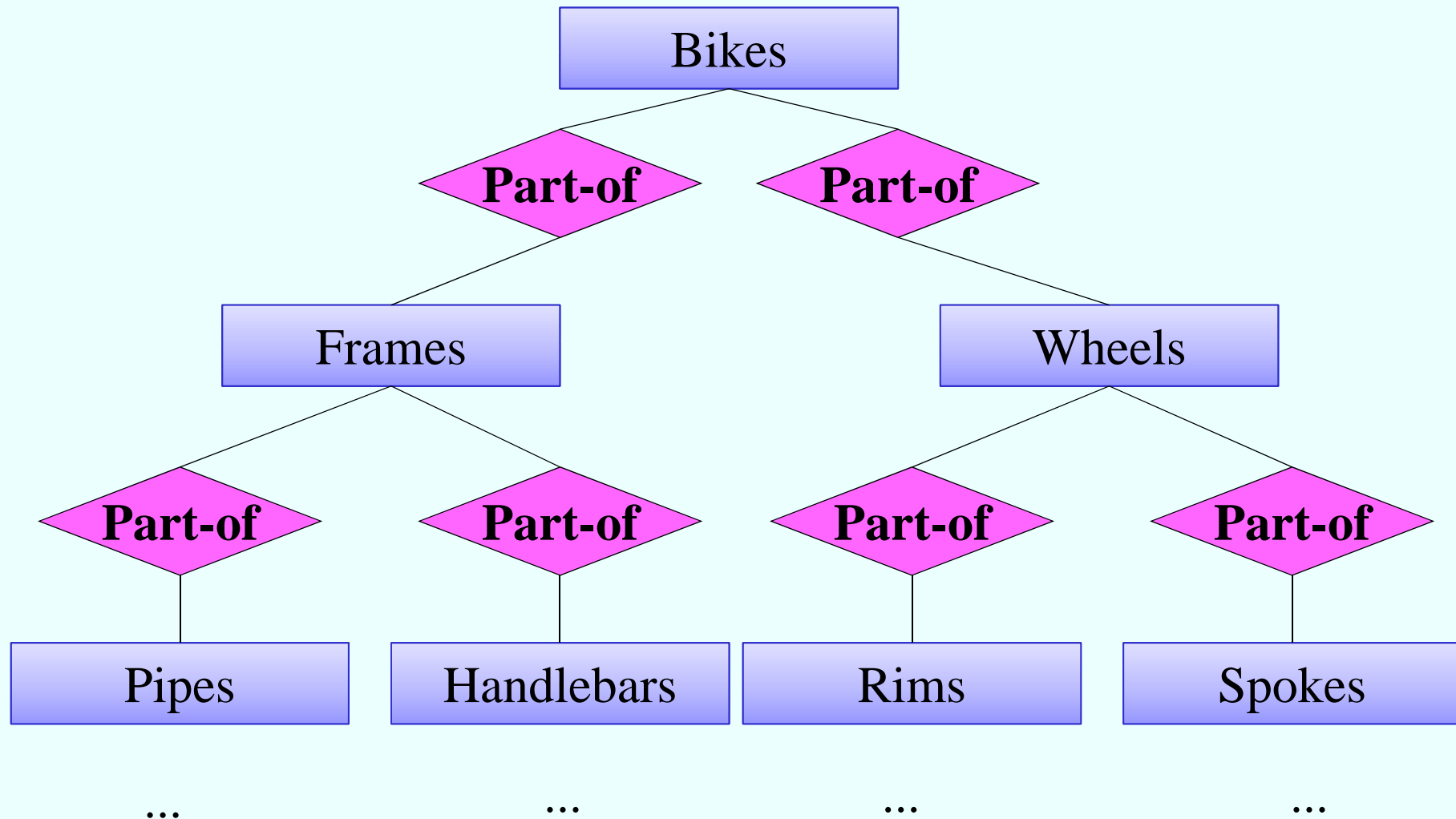

Aggregation and Generalization

